

# Handset

## TXH



## Features

- ◆ TXH is a wireless RF remote handset designed for the applications of home care and furniture. Paired with TXA receiver and you can enjoy the cable-free environment.
- ◆ Main applications : home care, furniture
- ◆ Frequency : 2.4GHz
- ◆ Operating distance : approx. 8 m
- ◆ Support memory function (TXH4) or without memory function (TXH3)
- ◆ Max. number of motors this handset can drive : 3
- ◆ Available number of buttons : 2, 4, 6, 8 or 9
- ◆ IP protection level : IP20
- ◆ Color : Silver
- ◆ Handset with hook for easy placement
- ◆ LED indicator
- ◆ Unique RF ID Code

# Compatibility

## 1. Receiver

TXA RF receiver



Compatibility Matrix :

TXH model \ TXA model	TXA4	TXA5	TXA6	TXA7
TXH3	✓	N/A	✓	N/A
TXH4	N/A	✓	N/A	✓

## Dimension

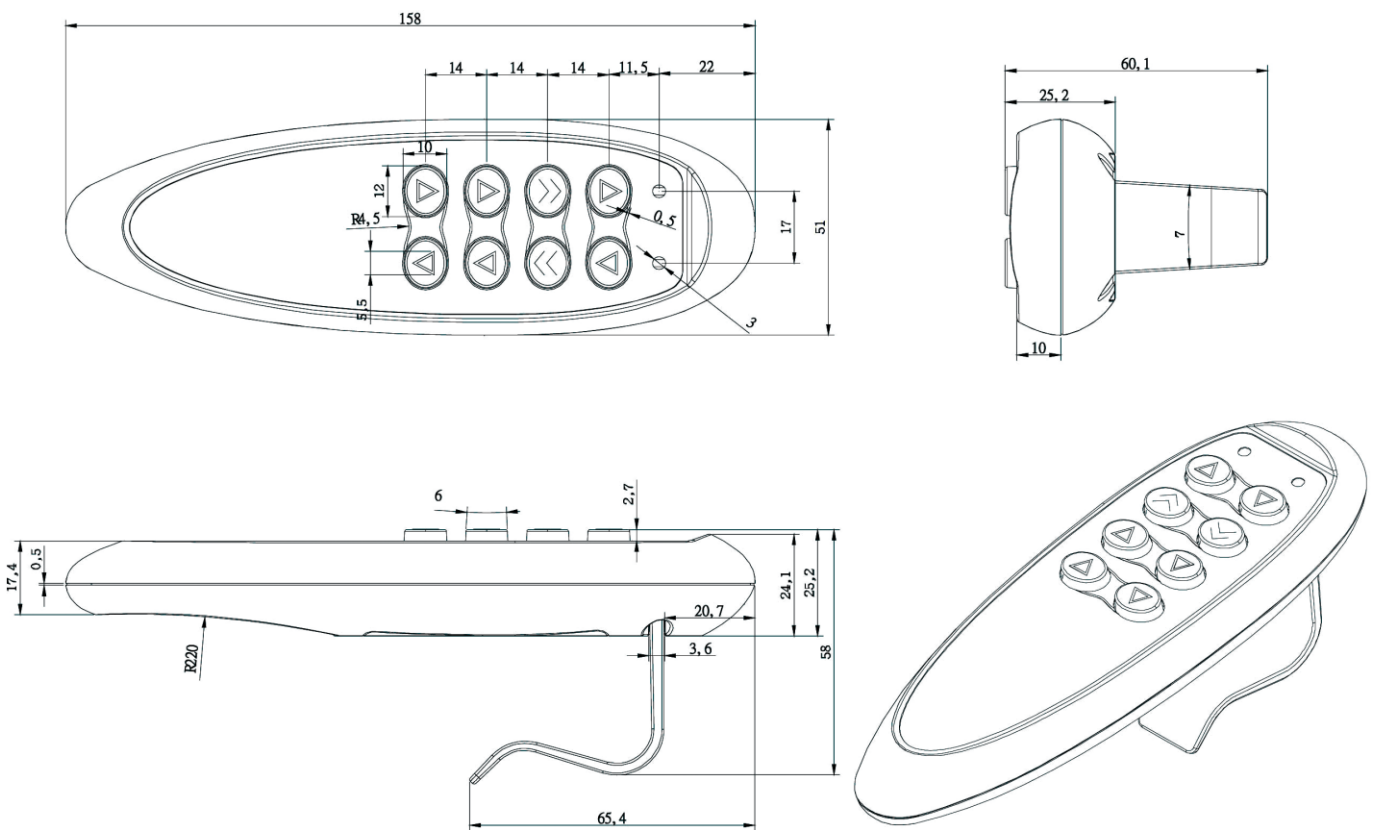

Unit: mm

# Ordering Key

TXH□—□□—□—□□—□□□—□□

## Model

- 3 : TXH3 (Without memory function)
- 4 : TXH4 (Support memory function)

## Buttons

- 02 : 2 buttons
- 04 : 4 buttons
- 06 : 6 buttons
- 08 : 8 buttons
- 09 : 9 buttons (Available for TXH4 only)

## Number of Motors

- 1 : 1 motor
- 2 : 2 motors
- 3 : 3 motors

## Functions

- 00 : Standard
- 01 : Joint movement (Refer to paragraph of Standard Panel Artwork)
- 04 : Joint movement + Memory function

## Hook

- H30 : Hook (30mm gap)
- H50 : Hook (50mm gap)







## Color

- 0 : Standard (Silver)
- Z : Customized

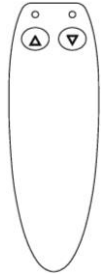
## Panel artwork code

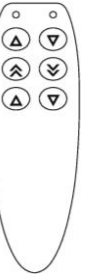
- A~F : Refer to paragraph of Standard Panel Artwork
- Z : Customized

# Standard Panel Artwork

Code	A		B		C		D		E		F	
<b>Model</b>	TXH3		TXH3		TXH3		TXH3		TXH3		TXH4	
<b>Motors</b>	1 drive		2 drive		2 drives		3 drives		3 drives		2 drives	
<b>Button Definition</b>	1+	1-	1+	1-	1+	1-	1+	1-	1+	1-	1+	1-
					1+2+	1-2-			1+2+	1-2-	1+2+	1-2-
			2+	2-	2+	2-	2+	2-	2+	2-	2+	2-
						3+	3-	3+	3-			
<b>Artwork</b>												
<b>Functions</b>	Standard		Standard		Joint movement		Standard		Joint movement		Joint movement + Memory function	

## Terms of Use

The user is responsible for determining the suitability of MOTECK products for specific applications. Due to continuous development in order to improve its products, MOTECK products are subject to frequent modifications and changes without prior notice. MOTECK reserves the right to discontinue the sale of any products displayed on its website or listed in its catalogue or other written materials drawn up by MOTECK.